

Secondary Glazing

Section Identification Guide

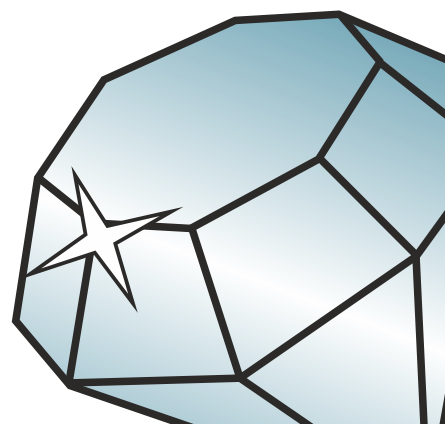

DURATION
WINDOWS



Contents

Systems	3
Horizontal sliders	4
Economy Sections	5
Luxury Subframe Sections	6
Slim Line Equal Leg	7
Vertical Sliders	8
Tilt-Back	9
Balanced	10
Non-Balanced	11
Heavy Duty & Sections	12
Friction Hinged & Sections	13
Butt Hinged & Sections	14
Medium Duty Hinged	15
Combination Units	15
Lift Outs & Sections	16
Fixed	17
Fly Screens	18
Trickle Vents & Trims	19

System Specification

SECTIONS	Outer frames and insert panels are made from warp free rigid sections of extruded aluminium alloy 6063 T6 B.S. 1474 (HE9TE).
FINISH	Our standard finish is white semi-gloss polyester powder coated aluminium to B.S. 6496. Silver Anodised, Brown and RAL colours are available at extra cost. Most wooden sub-frames are pre-primed in white. Brown units are supplied with hardwood unpainted sub-frames and trims.
WEATHERING	Moisture repellent, rot free silicone treated polypropylene pile strip is fitted to all insert panels.
GLAZING	4mm or 6mm float glass is used in accordance with B.S.CP 152 and 4mm, 6mm toughened, 6.4mm laminated are used in accordance with B.S.6262. All glazing is carried out at the factory prior to despatch, each panel being bedded in Glazepta synthetic rubber gaskets thus providing a cushioning effect.

We reserve the right to make changes to the product specification as technical developments dictate, and without prior notice.
Pictures shown are for illustrative purposes and are not binding in detail, colour or specification.

Secondary Systems

Our secondary glazing is available in four main systems; Economy Odd Leg, Slim-Line Equal Leg, Subframe and Heavy Duty. Each system is available in a range of different styles as listed below.

Economy Odd Leg

Our Economy Odd Leg system is a very cost effective aluminium secondary glazing system. It is easy to fit, with pre-drilled fixing holes. Simply face fix your secondary glazing onto the existing windows.

Available Styles:

- Fixed
- Two Track Horizontal Slider
- Balanced Vertical Slider (No tilt facility)
- Non-Balanced Vertical Slider (No tilt facility)
- Butt & Friction Hinged
- Lift Out



Face Fix

Luxury Subframe

Our Luxury Subframe system has an additional wooden frame that wraps around the aluminium frame. The subframes come in a choice of wood types and depths for face fixing or reveal fixing. Trims are available to give a neat clean finish.

Available Styles:

- Two & Three Track Horizontal Sliders
- Tilt Back Balanced Vertical Slider
- Balanced Vertical Slider (No tilt facility)
- Non-Balanced Vertical Slider (No tilt facility)
- Butt & Friction Hinged
- Lift Out

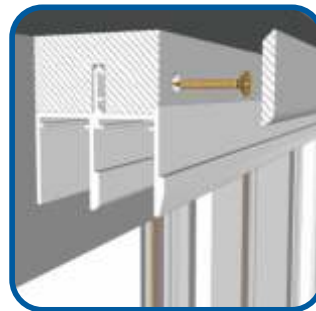

Face Fix



Reveal Fix

Slim-Line Equal Leg

Our Slim-Line secondary offers the slimmest sight-lines out of our four systems. The system is all aluminium and can be face or reveal fixed.

Available Styles:

- Two Track Horizontal Slider
- Tilt Back Balanced Vertical Slider
- Balanced Vertical Slider (No tilt facility)
- Non-Balanced Vertical Slider (No tilt facility)
- Lift Out



Face Fix



Reveal Fix

Heavy Duty

Our Heavy Duty system is stronger and more robust than our other secondary glazing systems. The thicker frames enable it to take double glazed sealed units and achieve larger maximum sizes.

Available Styles:

- Two Track Horizontal Slider
- Balanced Vertical Slider (No tilt facility)



Reveal Fix

Horizontal Sliders

Designs and Sizes

Horizontal Sliding secondary windows are available in 2,3,4 or 5 panel configurations, sliding on a track system with nylon skids and fitted with spring loaded aluminium catches engaging on the inside of the outer frame jambs for improved security. All sliding panels interlock at meeting styles thus providing a draught proof seal.

Two Track Designs

Two Panels - Both Slide

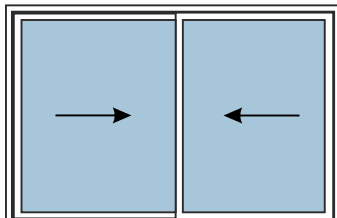

Three Panels - All Sliding

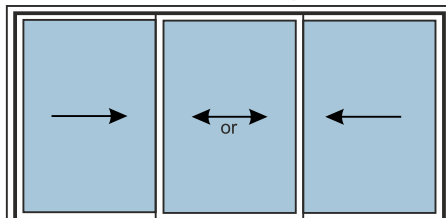

Three Panels: Centre Fixed

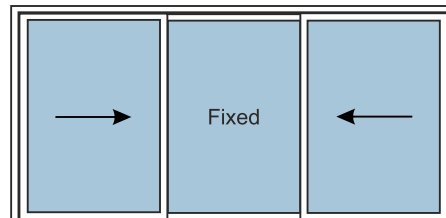

Four Panels: All Sliding

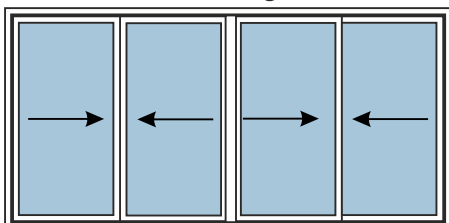

Five Panels: Centre Fixed - Four Panels Slide*

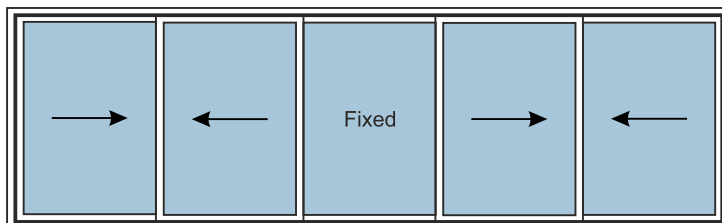

* Configuration only applies to Economy, Slim-Line and Luxury Subframe

Three Track Designs

Three Panels - All Sliding

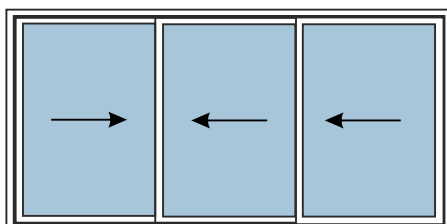

This three track, three panel horizontal slider gives maximum ventilation and access to the prime windows.

Recommended Sizes

These measurements are representative of our Economy, Slim-Line and Luxury Subframe Systems.

2 Panel	
Min Width	400 mm
Max Width	2500 mm
Min Height	400 mm
Max Height	1980 mm

3 Panel	
Min Width	600 mm
Max Width	3750 mm
Min Height	400 mm
Max Height	1980 mm

4 Panel	
Min Width	800 mm
Max Width	4900 mm
Min Height	400 mm
Max Height	1980 mm

5 Panel	
Min Width	1000 mm
Max Width	4900 mm
Min Height	400 mm
Max Height	1980 mm

Please note: All these sizes are recommended sizes and special requests to go under or over these sizes may be possible but will not carry the standard guarantee.

Economy Horizontal Slider

Sections

Two Panels - Both Slide

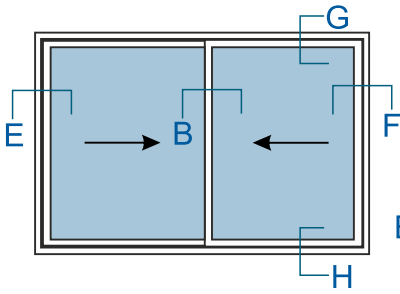

Three Panels - All Sliding

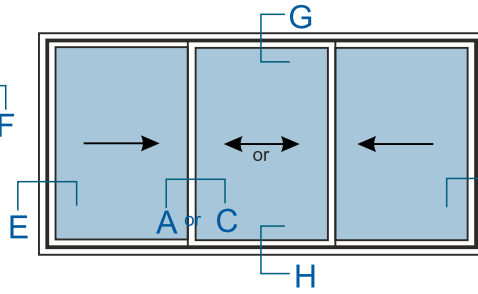

Three Panels: Centre Fixed

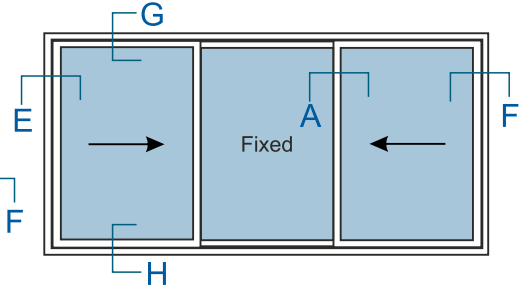

Four Panels: All Sliding

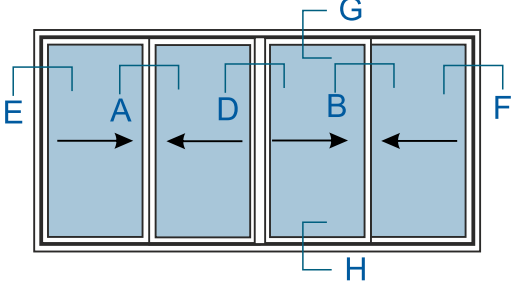

Five Panels: Centre Fixed - Four Panels Slide

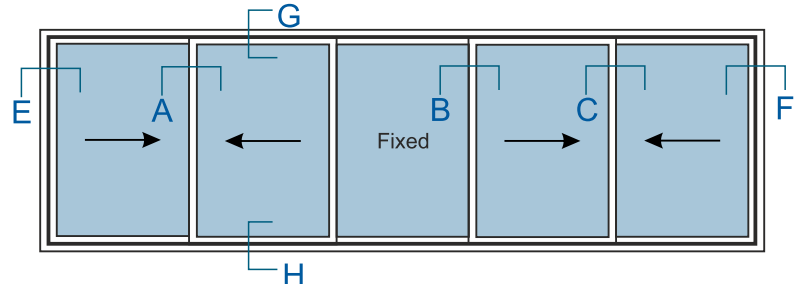

Two Track Only

Section A

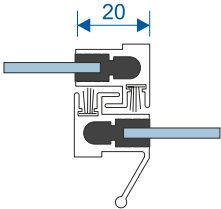

Section B

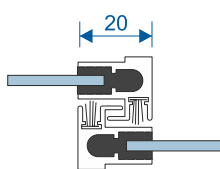

Section C

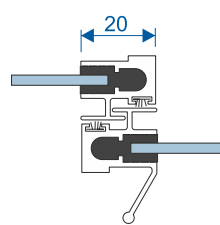

Section D

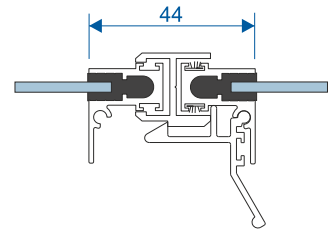

Section E

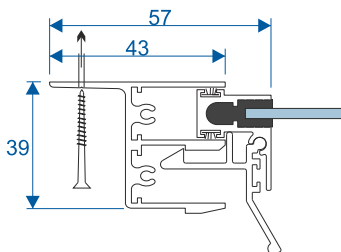

Section F

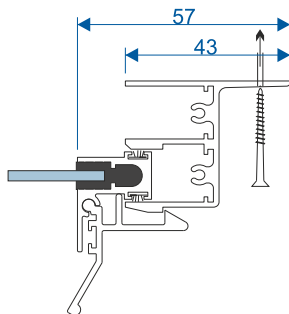

Section G

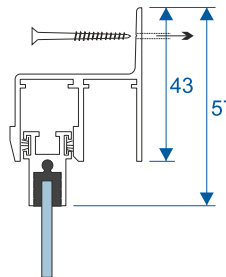

Section H

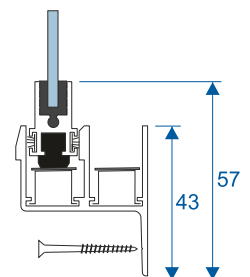

For more in-depth technical please contact us or consult our website.

Subframe Horizontal Slider

Sections

Two Panels - Both Slide

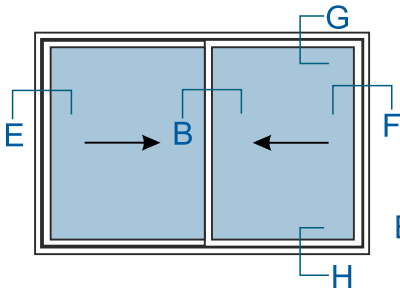

Three Panels - All Sliding

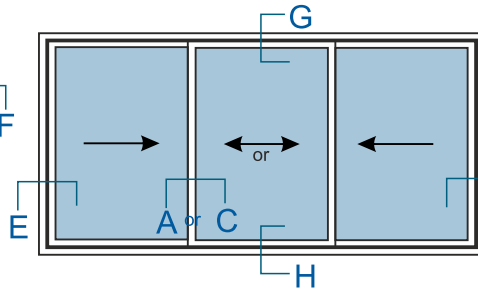

Three Panels: Centre Fixed

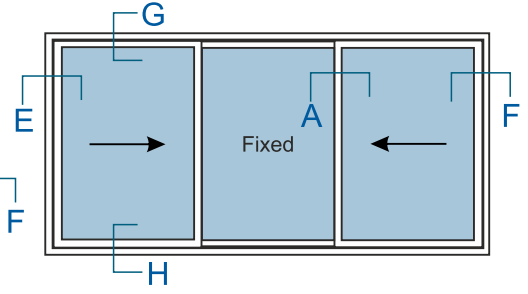

Four Panels: All Sliding

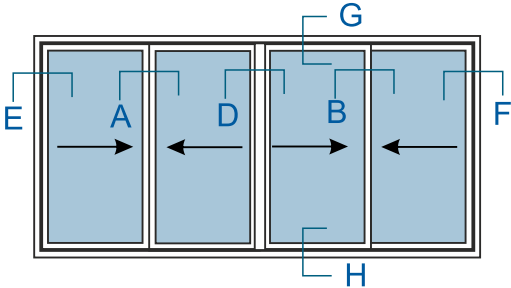

Five Panels: Centre Fixed - Four Panels Slide

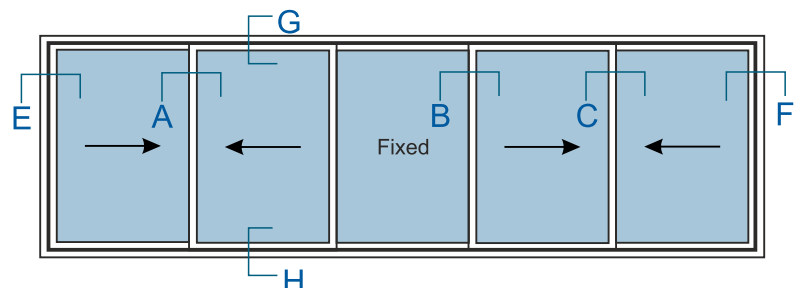

Section A

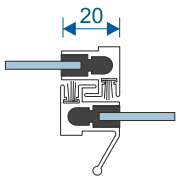

Section B

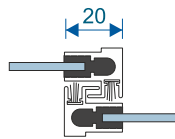

Section C

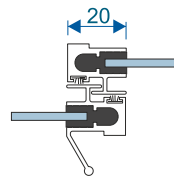

Section D

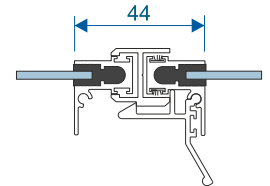

Note drawings below show both face fix and reveal fix. Reveal fix shown by the hatched area.

Two Track

Section E

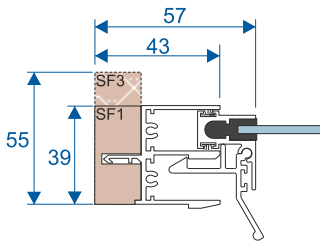

Section F

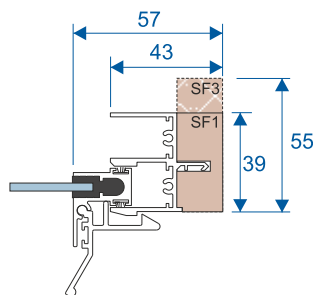

Section G

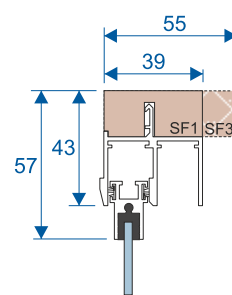

Section H

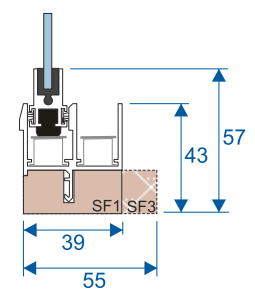

Three Track

Section E

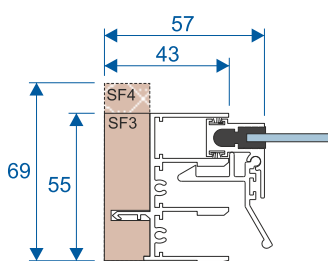

Section F

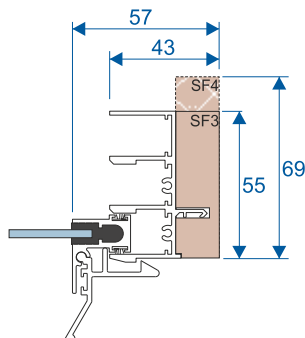

Section G

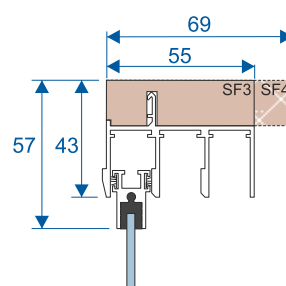

Section H

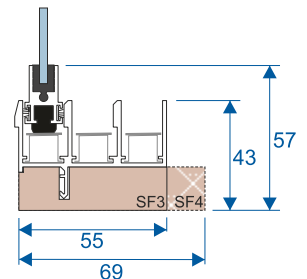

For more in-depth technical please contact us or consult our website.

Slim-Line Horizontal Slider

Sections

Two Panels - Both Slide

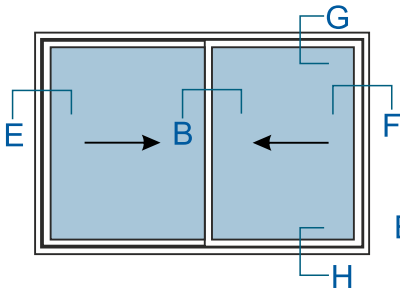

Three Panels - All Sliding

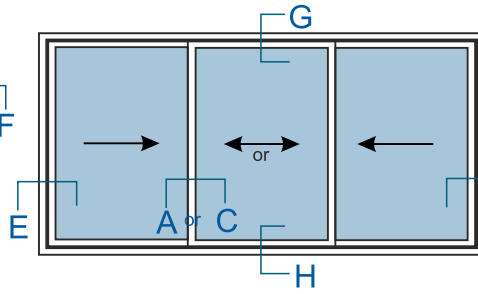

Three Panels: Centre Fixed

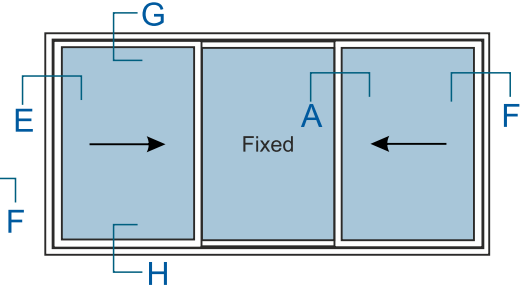

Four Panels: All Sliding

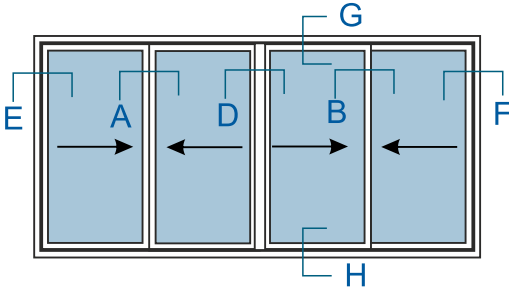

Five Panels: Centre Fixed - Four Panels Slide

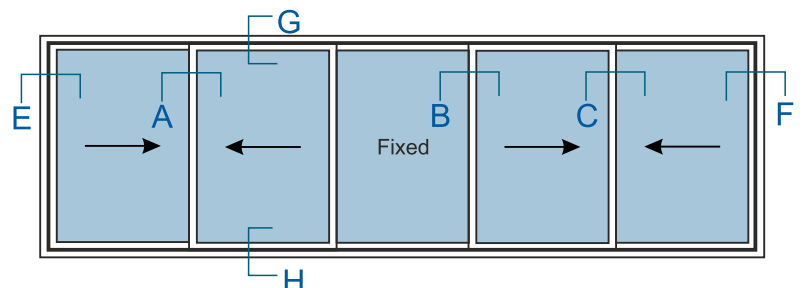

Section A

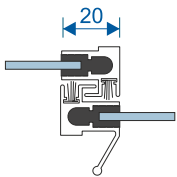

Section B

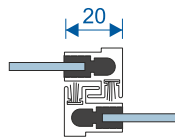

Section C

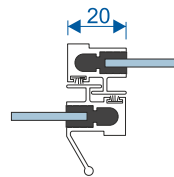

Section D

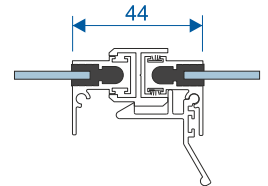

Face Fixed

Section E

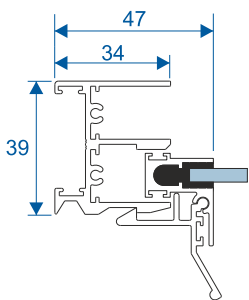

Section F

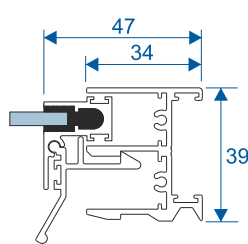

Section G

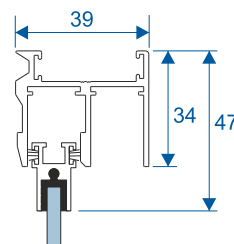

Section H

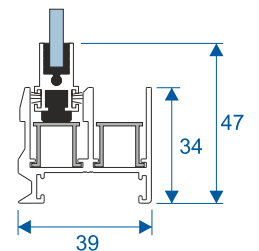

Reveal Fixed

Section E

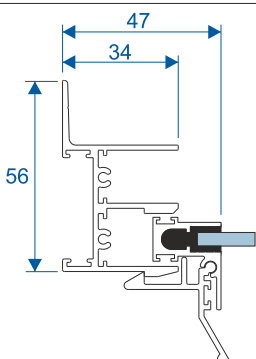

Section F

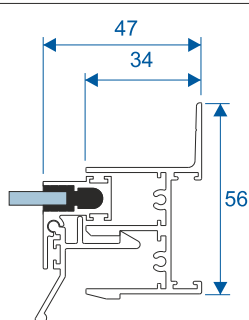

Section G

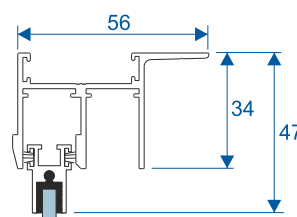

Section H

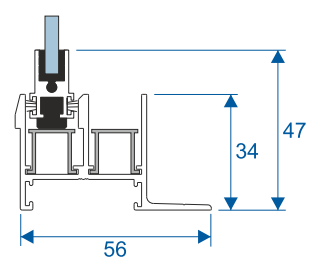

For more in-depth technical please contact us or consult our website.

Vertical Sliders

Designs and Sizes

Vertical Sliding secondary glazing is ideal for heat and sound proofing traditional wooden box sash windows, or any windows that have horizontal bars. Panels slide open in the same way as vertical sliding sash windows and provide easy access to the existing window.

Balanced Tilt Back - Subframe or Slim-Line

Balanced Tilt Back Vertical Sliders are hung on spiral balances concealed in the jambs, and adjusted to suit the weight of the panels. Panels are held closed with a Fitch Fastener positioned in the centre of the transom bar. The head of each panel has a spring loaded catch in the corner, enabling each panel to tilt back individually for ease of cleaning and access to prime window for decorating.

Recommended Sizes

Min Width	400 mm
Max Width	1250 mm
Min Height	800 mm
Max Height	2450 mm

Please note

- Balanced Tilt Back is not available in Odd Leg Systems
- Maximum panel weights are 18kg
- 4mm Glass 10.2kg m²
- 6mm Glass 15.2kg m²
- All these sizes are recommended sizes and special requests to go under or over these sizes may be possible but will not carry the standard guarantee.

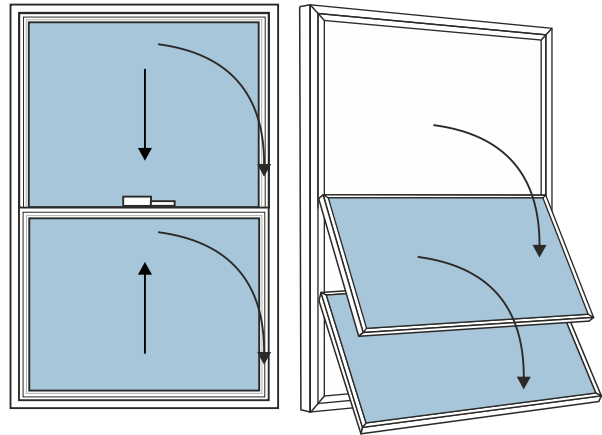

Balanced - Economy, Slim-Line or Subframe

Balanced Vertical Sliders are hung on spiral spring balances concealed in the jambs and adjusted to suit the weight of the panels. Both panels are held closed with a Fitch Catch fastener positioned in the centre of the transom bar. The panels cannot be removed or tilted in for cleaning.

Recommended Sizes

Min Width	400 mm
Max Width	1250 mm
Min Height	800 mm
Max Height	2450 mm

Please note

- Maximum panel weights are 18kg
- 4mm Glass 10.2kg m²
- 6mm Glass 15.2kg m²
- All these sizes are recommended sizes and special requests to go under or over these sizes may be possible but will not carry the standard guarantee.

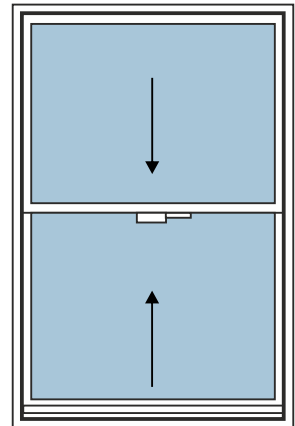
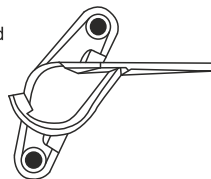

Non-Balanced - Economy, Slim-Line or Subframe

THE OPERATOR MUST SUPPORT THE WEIGHT OF THE PANEL WHEN SLIDING. The panels are held with spring loaded nylon bolts which locate in pre-set stop positions in the jamb to hold the panel in the desired open position. Panels can be removed for easy cleaning.

Recommended Sizes

Min Width	400 mm
Max Width	1250 mm
Min Height	600 mm
Max Height	1850 mm

Please note

- Maximum panel weights are 18kg
- 4mm Glass 10.2kg m²
- 6mm Glass 15.2kg m²
- All these sizes are recommended sizes and special requests to go under or over these sizes may be possible but will not carry the standard guarantee.

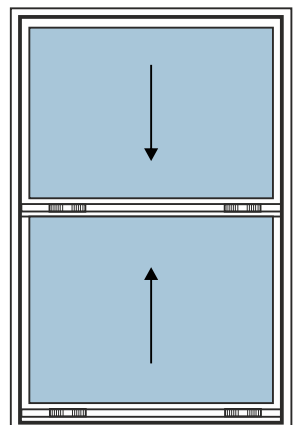
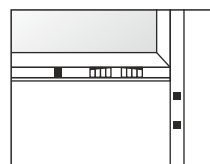

Tilt- Back Vertical Slider

Sections

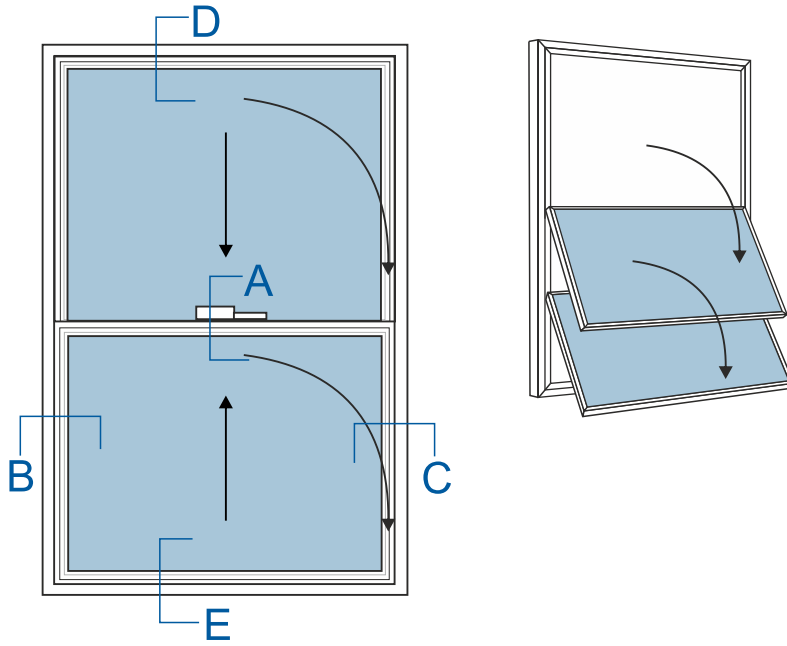

Section A

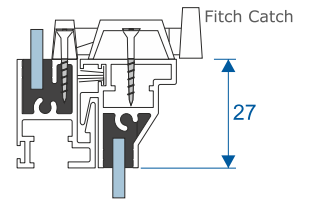

Note subframe drawings below show both face fix and reveal fix. Reveal fix shown by the hatched area.

Subframe

Section B

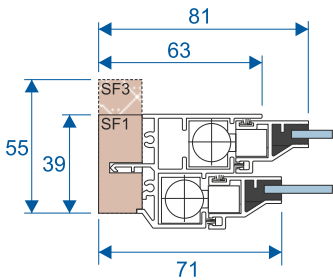

Section C

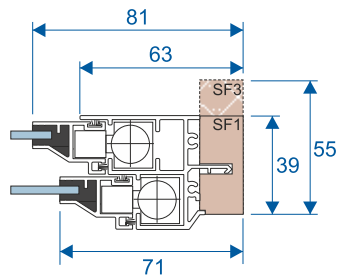

Section D

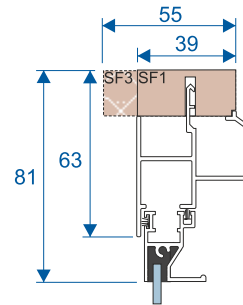

Section E

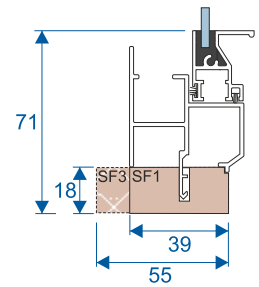

Slim-Line

Section B

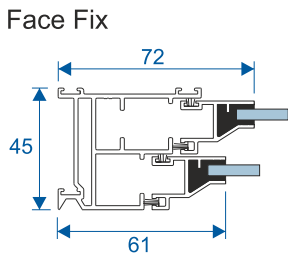

Section C

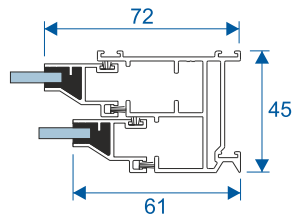

Section D

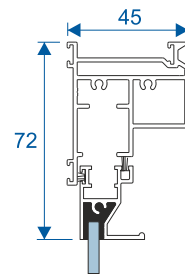

Section E

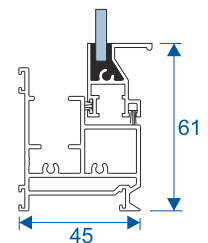

Reveal Fix

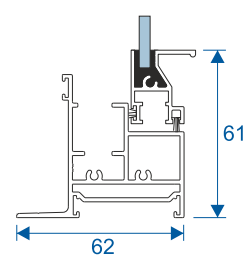
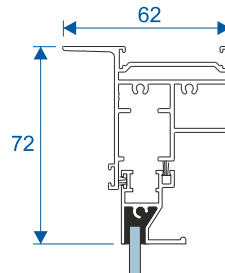
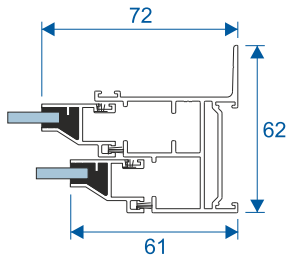
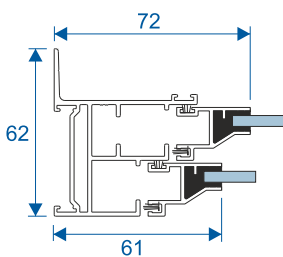

For more in-depth technical please contact us or consult our website.

Balanced Vertical Slider

Sections

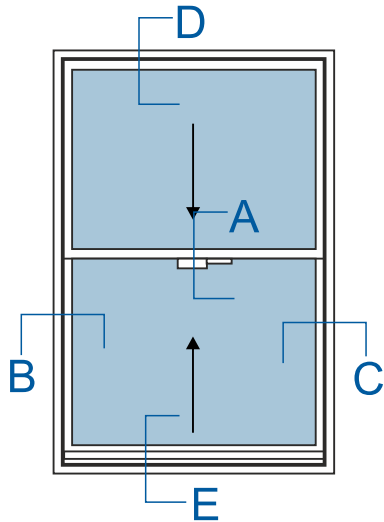

Section A

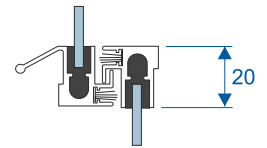

Economy

Section B

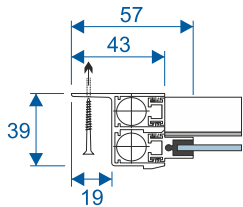

Section C

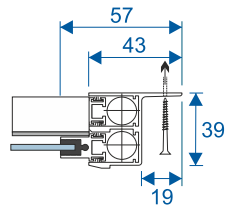

Section D

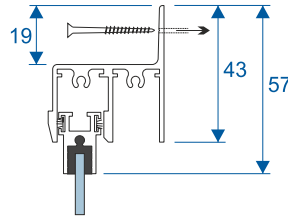

Section E

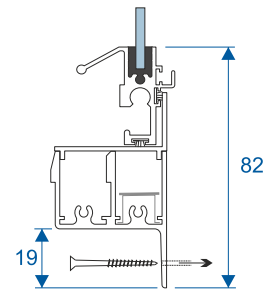

Note drawings below show both face fix and reveal fix. Reveal fix shown by the hatched area.

Subframe

Section B

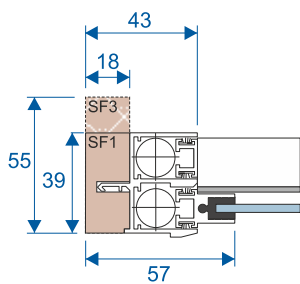

Section C

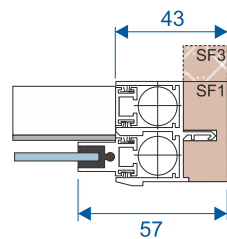

Section D

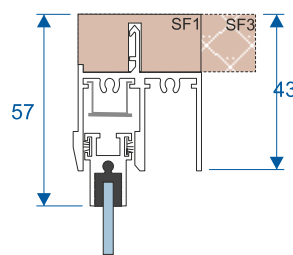

Section E

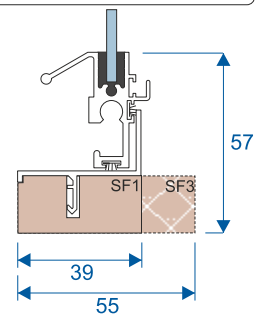

Slim-Line

Section B

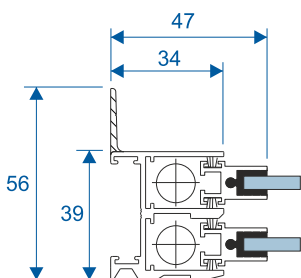

Section C

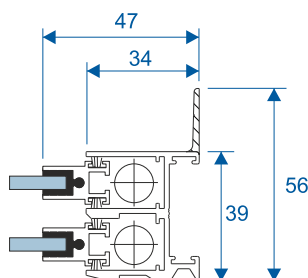

Section D

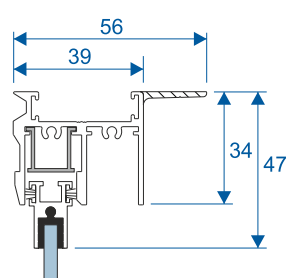

Section E

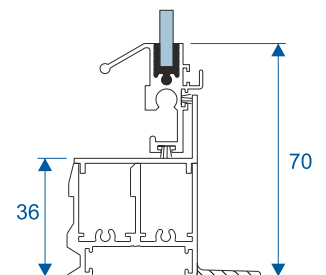

For more in-depth technical please contact us or consult our website.

Heavy Duty

Designs, Sizes & Sections

Heavy Duty secondary glazing has a more robust frame and also has the option of either single glazed or double glazed sealed units. Our heavy duty system is available as horizontal or vertical sliding and is reveal fix only.

Recommended Sizes - Horizontal Sliding

2 Panel	
Min Width	800 mm
Max Width	3000 mm
Min Height	400 mm
Max Height	2400 mm

3 Panel	
Min Width	1200 mm
Max Width	4500 mm
Min Height	400 mm
Max Height	2400 mm

4 Panel	
Min Width	1600 mm
Max Width	4900 mm
Min Height	400 mm
Max Height	2400 mm

Recommended Sizes - Vertical Sliding

Sizes	
Min Width	400 mm
Max Width	1500 mm
Min Height	900 mm
Max Height	2800 mm

Please note:

- Maximum panel weights are 50kg
- 4mm Glass - Single Glazed: 10.2kg m² / Double Glazed: 20.4kg m²
- 6mm Glass - Single Glazed: 15.2kg m² / Double Glazed: 30.4kg m²
- All these sizes are recommended sizes and special requests to go under or over these sizes may be possible but will not carry the standard guarantee.
- Panels are not able to be lifted out for cleaning.

Two Panel Horizontal Slider

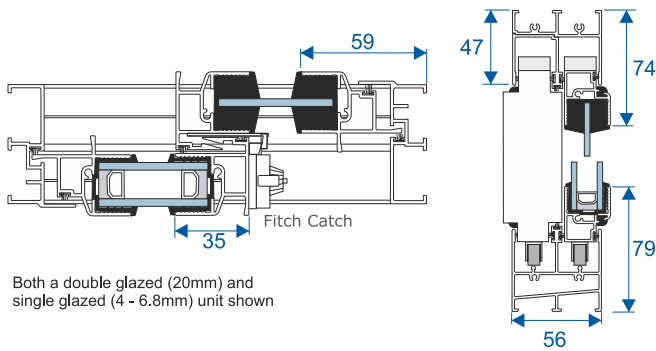

Both a double glazed (20mm) and single glazed (4 - 6.8mm) unit shown

Vertical Sliding Heavy Duty Secondary

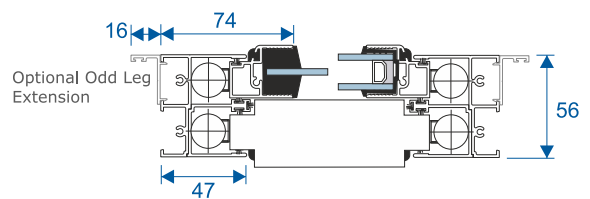

Three Panel All Sliding Horizontal Slider

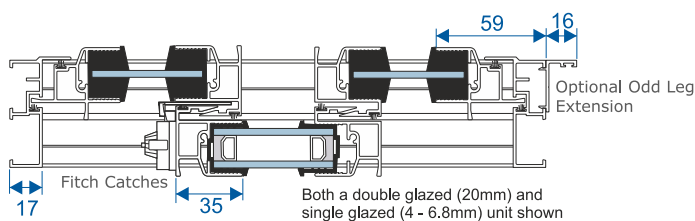

Both a double glazed (20mm) and single glazed (4 - 6.8mm) unit shown

Four Panel All Sliding Horizontal Slider

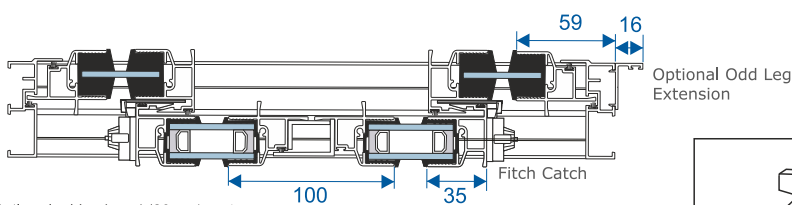

Both a double glazed (20mm) and single glazed (4 - 6.8mm) unit shown

16mm odd leg extension:

Both of our heavy duty systems as shown on this page can be fitted with an odd leg extension. This can be added to any part of the frame to make the frame longer on one side. Equally it can be placed on both sides (inside & out) of the frame to extend it for any reason you may need it on site.

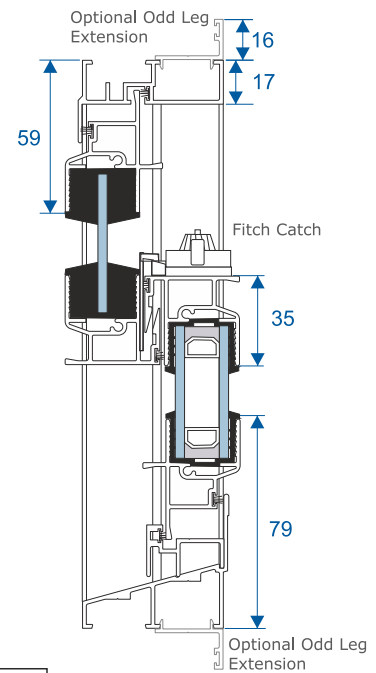

Both a double glazed (20mm) and single glazed (4 - 6.8mm) unit shown.

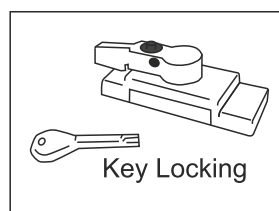

For more in-depth technical please contact us or consult our website.

Non-Balanced Vertical Slider

Sections

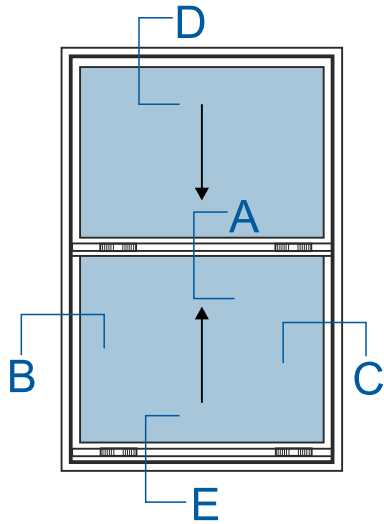

Section A

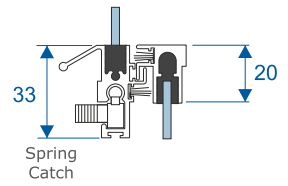

Economy

Section B

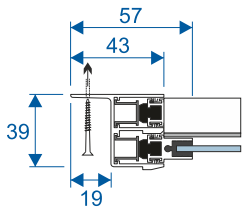

Section C

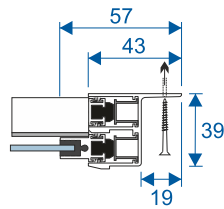

Section D

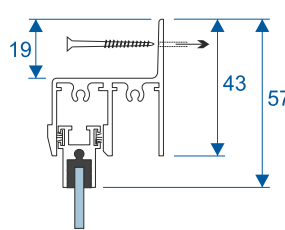

Section E

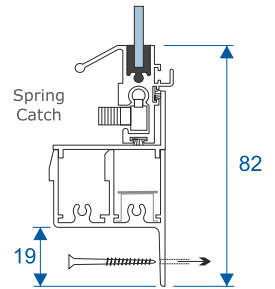

Note drawings below show both face fix and reveal fix. Reveal fix shown by the hatched area.

Subframe

Section B

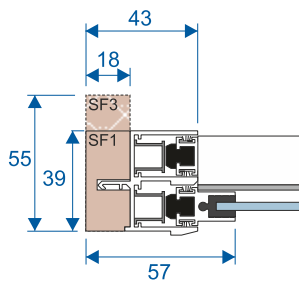

Section C

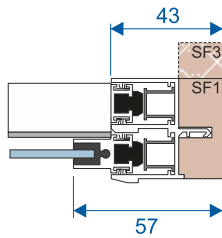

Section D

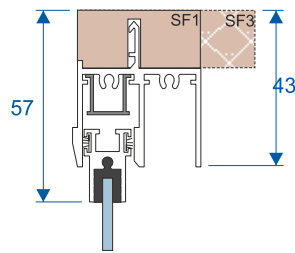

Section E

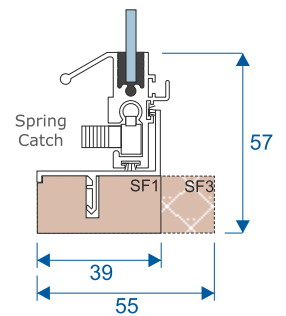

Slim-Line

Section B

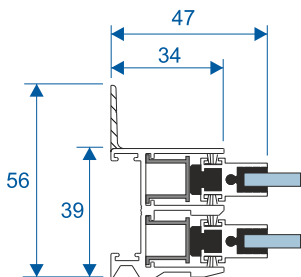

Section C

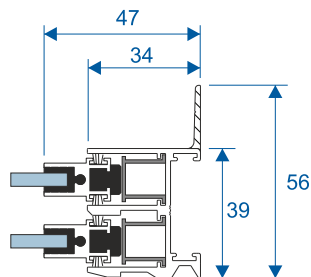

Section D

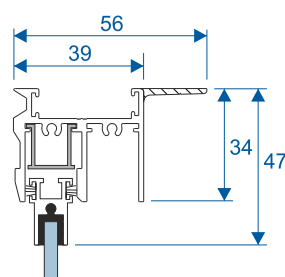

Section E

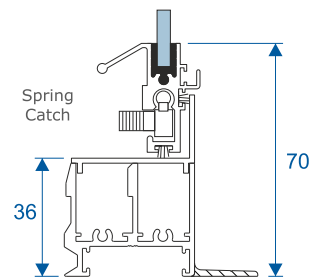

For more in-depth technical please contact us or consult our website.

Hinged Units

Friction Hinges

Single pane top hung or side hung (left or right) units are manufactured with Stainless Steel Friction Hinges to hold the casement to the desired position and fitted with a white painted Fitch Catch.

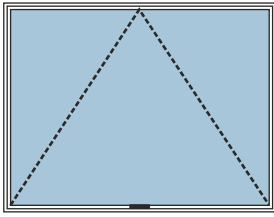

Top Hung (Friction Hinges)

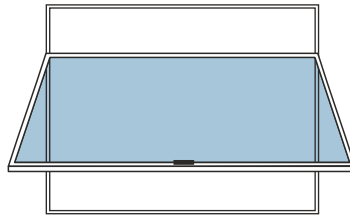

To Approx 65°

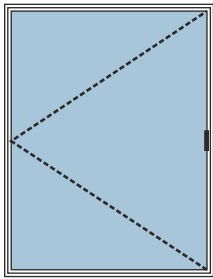

Side Hung (Friction Hinges)

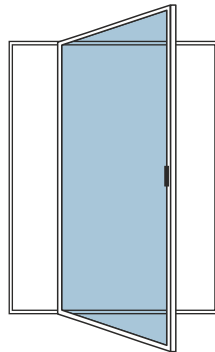

To Approx 65°

Top Hung Recommended Sizes

Min Width	350 mm
Max Width	1250 mm
Min Height	400 mm
Max Height	1000 mm

Side Hung Recommended Sizes

Min Width	300 mm
Max Width	650 mm
Min Height	400 mm
Max Height	1250 mm

Please note that all these sizes are recommended sizes and special requests to go under or over these sizes may be possible but will not carry the standard guarantee.

Friction Hinges - Economy Sections

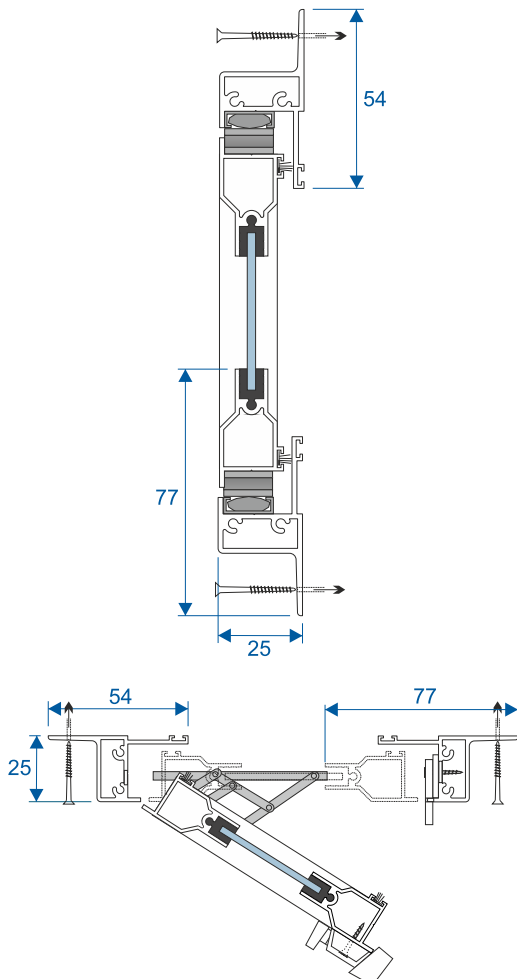

Friction Hinges - Subframe Sections

Note drawings below show both face fix and reveal fix. Reveal fix shown by the hatched area.

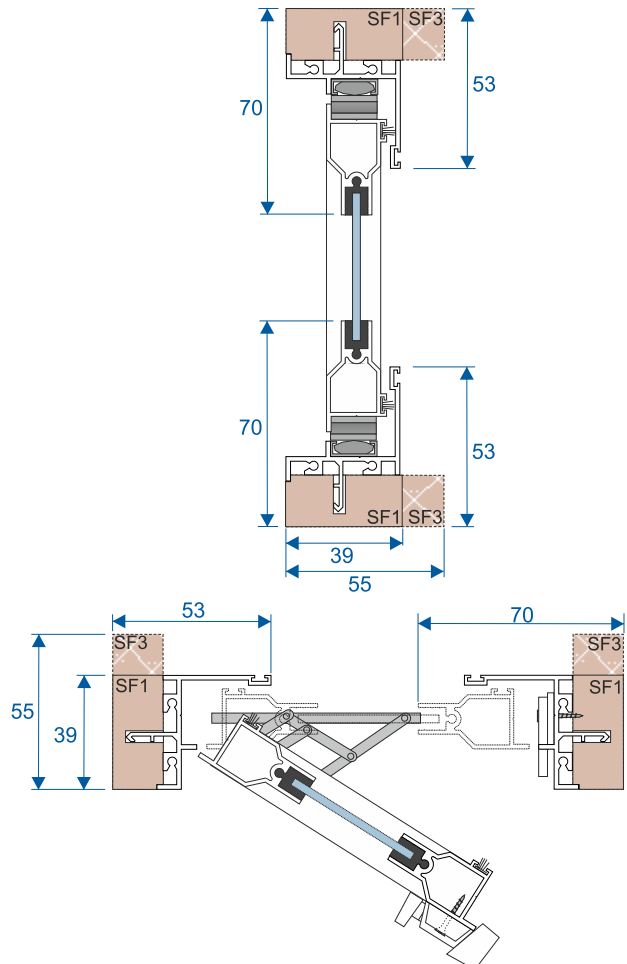

Hinged Units

Butt Hinges

Butt Hinged Units are manufactured as side hung and can be either single or double hinged as shown below. Heavy duty butt hinges are fitted to the casement enabling far greater access.

The single pane unit is fitted with a white painted Fitch Catch whilst the double unit is fitted with one or more Fitch Catches and has two concealed shoot bolts on the slave panel to secure it in a closed position.

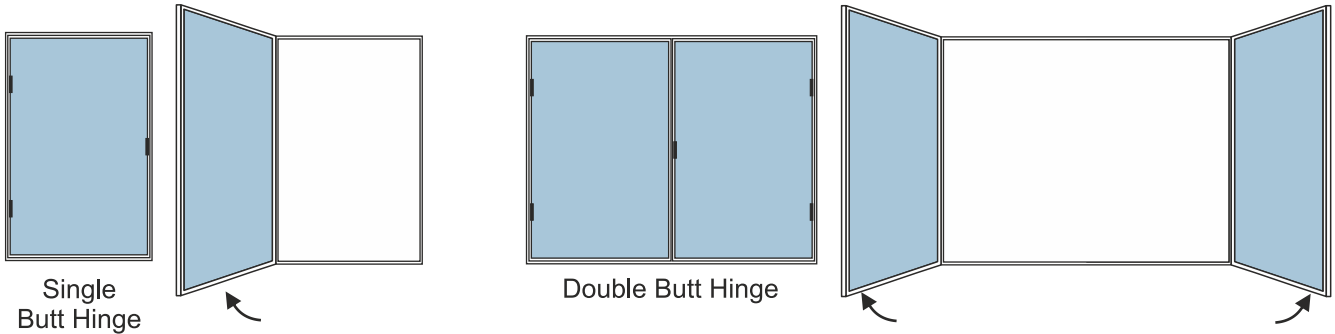

Recommended Sizes Single Butt	
Min Width	300 mm
Max Width	900 mm
Min Height	400 mm
Max Height	2100 mm

Recommended Sizes Double Butt	
Min Width	700 mm
Max Width	1800 mm
Min Height	400 mm
Max Height	2100 mm

Approximate Opening	
Economy	170°
Subframe	150°

Please note that all these sizes are recommended sizes and special requests to go under or over these sizes may be possible but will not carry the standard guarantee.

Butt Hinges - Economy Sections

Butt Hinges - Subframe Sections

Note drawings below show both face fix and reveal fix. Reveal fix shown by the hatched area.

Single Butt

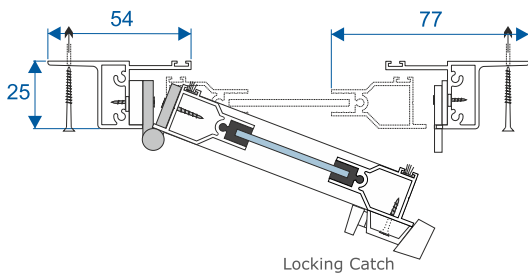

Single Butt

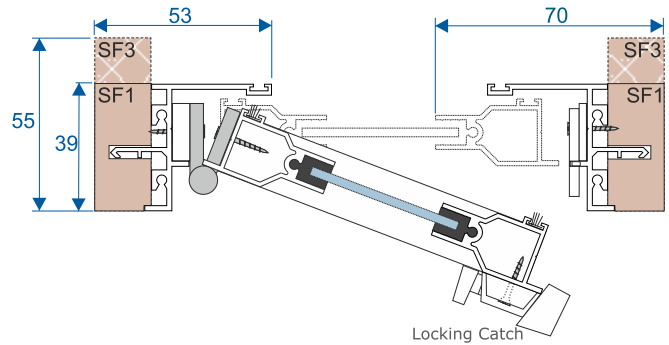

Double Butt

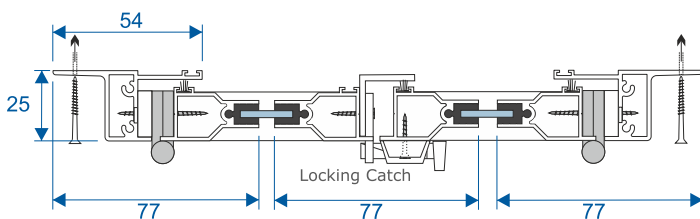

Double Butt

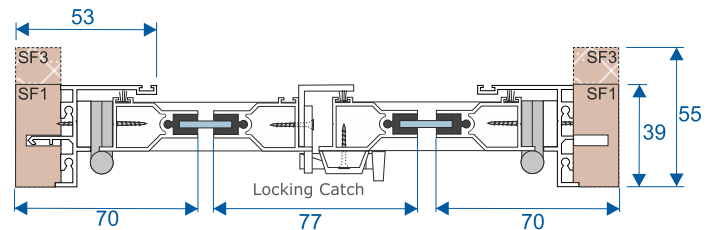

Hinged & Combination Units

Medium Duty Hinged Unit (Panel Only, No Frame)

These units consist of the PANEL ONLY i.e. no frame - and are supplied with medium duty plastic butt hinges and magnetic catch.

Recommended Sizes		
	Side Hung	Top Hung
Min Width	300 mm	300 mm
Max Width	900 mm	1250 mm
Min Height	400 mm	400 mm
Max Height	1250 mm	1250 mm

Please note that all these sizes are recommended sizes and special requests to go under or over these sizes may be possible but will not carry the standard guarantee. Also note that it is not always recommended to use the max size on both width and height.

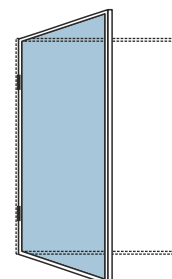
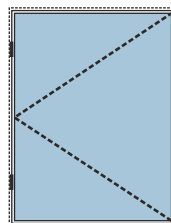
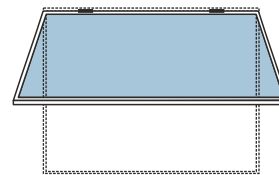
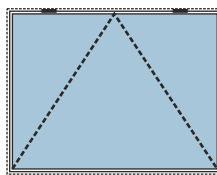

Combination Units

Units are supplied with one outer frame divided by a transom / mullion.

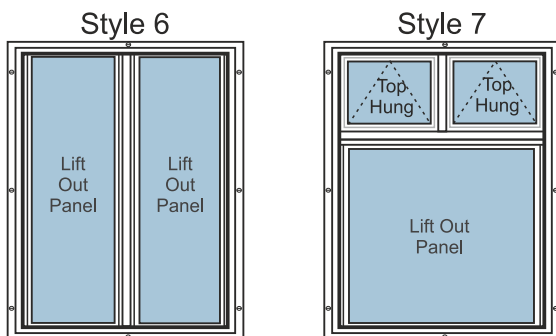
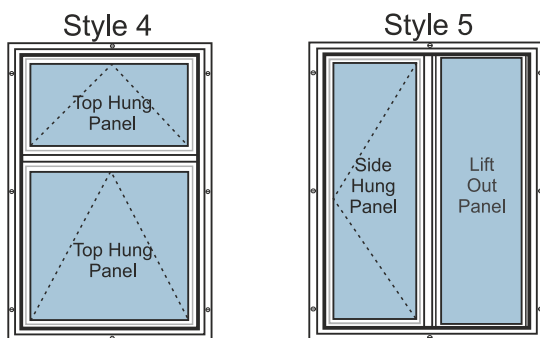
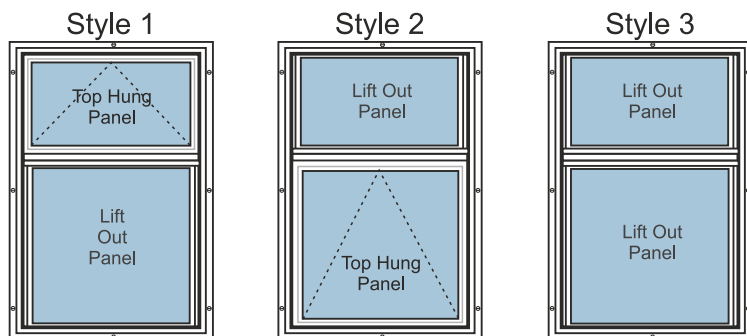

Recommended Max Sizes

Top Hung / Lift Out (Style 1)

Max Width	1200 mm
Max Height	2600 mm

Lift Out / Top Hung (Style 2)

Max Width	1200 mm
Max Height	2600 mm

Lift Out / Lift Out (Style 3)

Max Width	1200 mm
Max Height	3000 mm

Top Hung / Top Hung (Style 4)

Max Width	1200 mm
Max Height	2000 mm

Side Hung / Lift Out (Style 5)

Max Width	1800 mm
Max Height	1500 mm

Lift Out / Lift Out (Style 6)

Max Width	2400 mm
Max Height	1600 mm

2x Top Hung / Lift Out (Style 7)

Max Width	1600 mm
Max Height	2200 mm

Lift Outs

Lift Out Units

Lift Out Units are framed single pane windows with a removable panel for cleaning: They are not suitable for ventilation. The removable panel has a full length finger rail at the bottom to assist in lifting the panel out. Panels over 1400mm in height are fitted with retaining clips to prevent the panel from bowing.

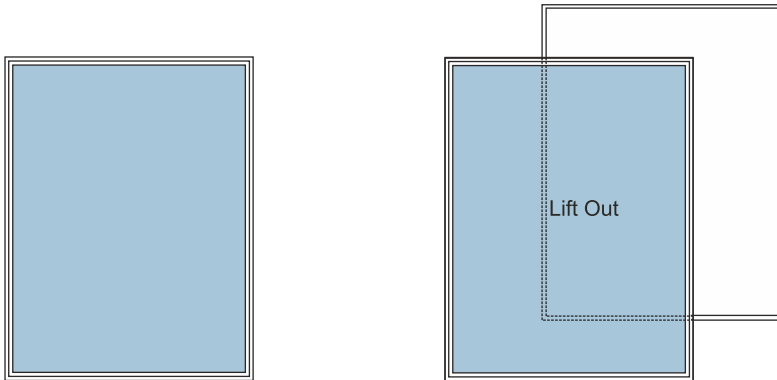

Lift Out Recommended Sizes

Min Width	300 mm	Min Height	300 mm
Max Width	1250mm	Max Height	2100mm

Please note that all these sizes are recommended sizes and special requests to go under or over these sizes may be possible but will not carry the standard guarantee.

Note drawings below show both face fix and reveal fix. Reveal fix shown by the hatched area.

Economy Lift Out Sections

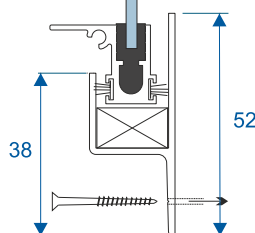
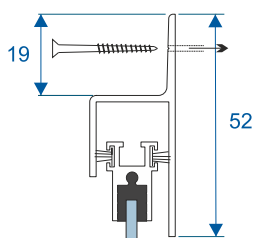
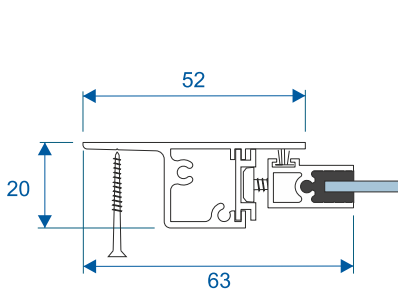

Subframe Lift Out Sections

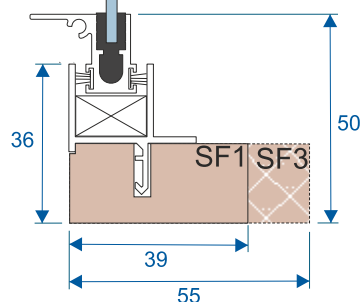
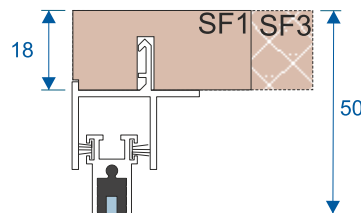
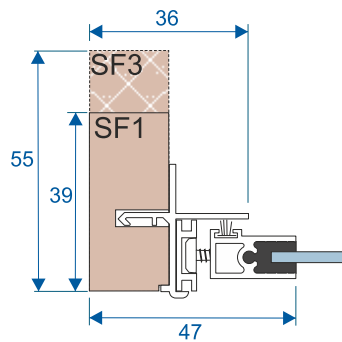

Slim-Line Lift Out Sections

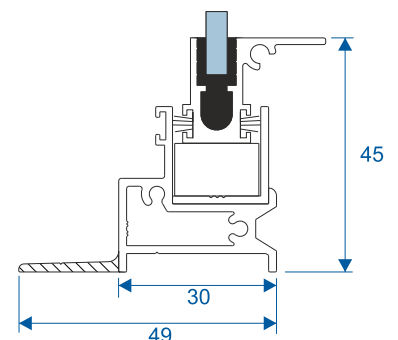
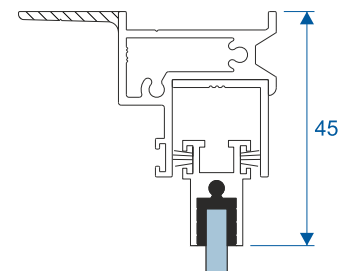
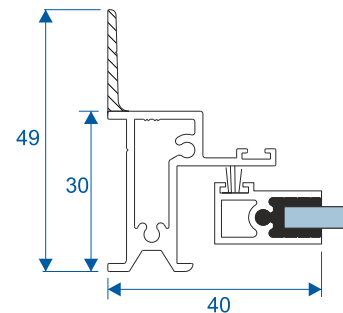

For more in-depth technical please contact us or consult our website.

Fixed

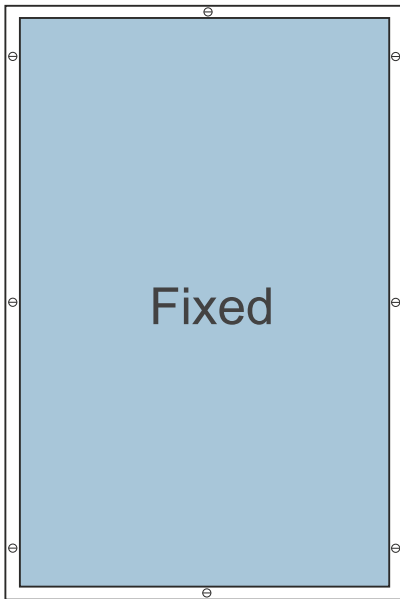

Fixed secondary glazing units are manufactured as a single pane glazed panel which fix directly to existing windows or doors with screws.

They have no opening mechanism and can not be easily removed for general cleaning or for ventilation.

The frames have pre-drilled fixing holes, prepped and countersunk ready for fixing.

Fixed Recommended Sizes

Min Width	300 mm	Min Height	300 mm
Max Width	1500 mm	Max Height	2500 mm

Please note that all these sizes are recommended sizes and special requests to go under or over these sizes may be possible but will not carry the standard guarantee.

Sections

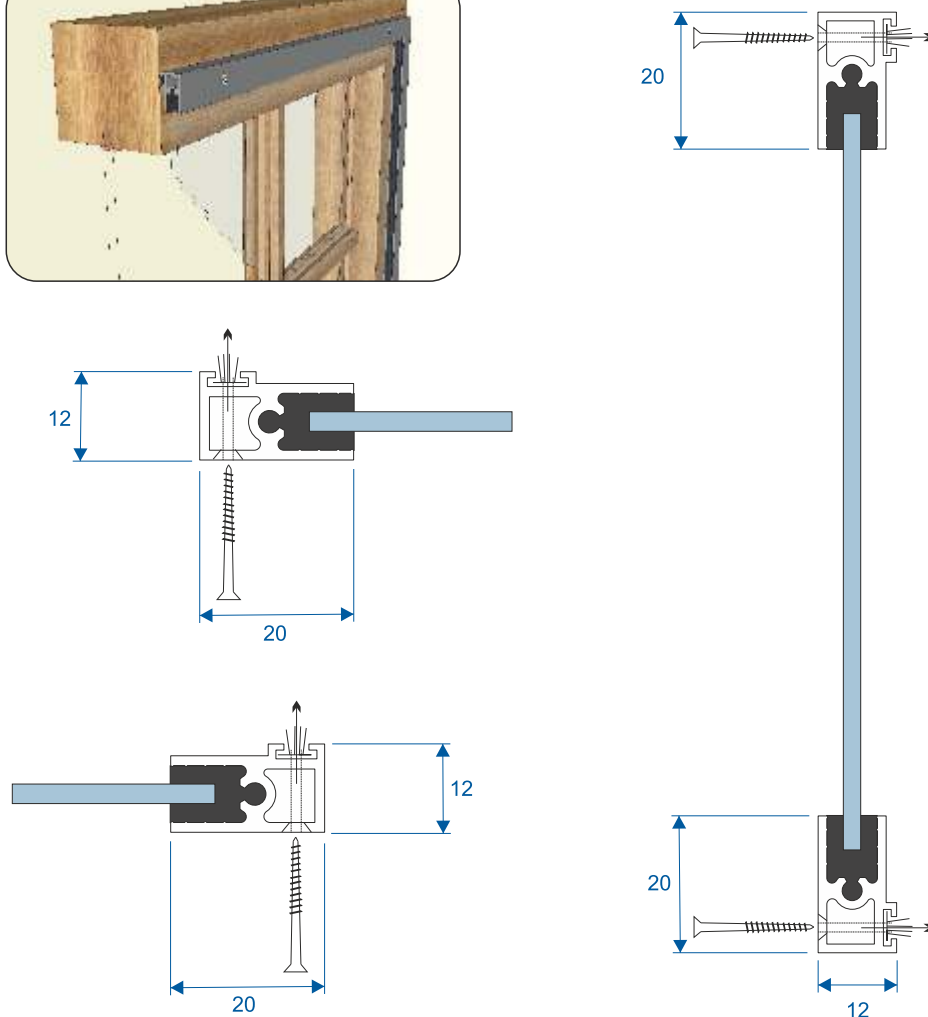

For more in-depth technical please contact us or consult our website.

Fly Screens

Fly Screen Windows

Manufactured from the same high quality materials as the glazed units these fine meshed panels allow windows to be opened without the fear of being invaded by flying insects.

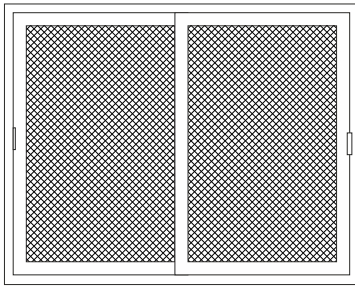

Horizontal Slider

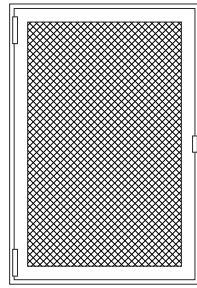

Hinged
(with Subframe)

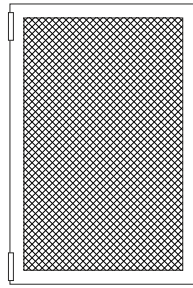

Hinged Panel
(no Subframe)

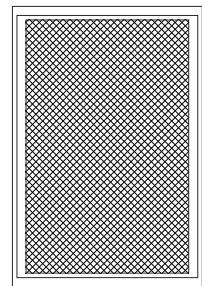

Lift Out

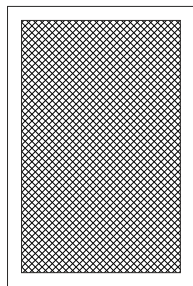

Fixed Panel
(No Subframe)

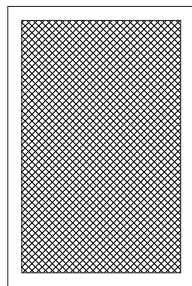

Insert Panel
(in place of Glazed Panel)

Recommended Max Sizes

Horizontal Slider

Max Width	1300 mm
Max Height	1200 mm

Hinged (With Frame)

Max Width	650 mm
Max Height	1200 mm

Hinged Panel (No Frame)

Max Width	650 mm
Max Height	1200 mm

Fixed Panel

Max Width	650 mm
Max Height	1200 mm

Lift Out

Max Width	650 mm
Max Height	1200 mm

Insert Panel (In Place Of Glazed Panel)

Max Width	650 mm
Max Height	1200 mm

Fly Screen Doors

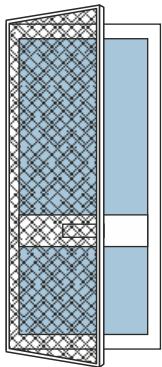

Section through Flyscreen Door showing typical installation inside the reveals

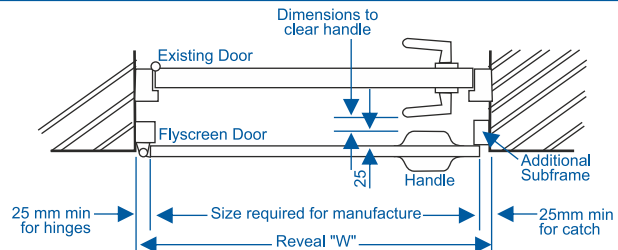

Features of Our Flyscreen Doors

- Maintenance Free Aluminium.
- Strong Nylon coated fibre glass mesh.
- Choice of White, Silver or Brown Finish.
- To Fit Doors up to 900mm x 2150mm.
- Inward or Outward opening.
- Will lift off for Easy Storage.

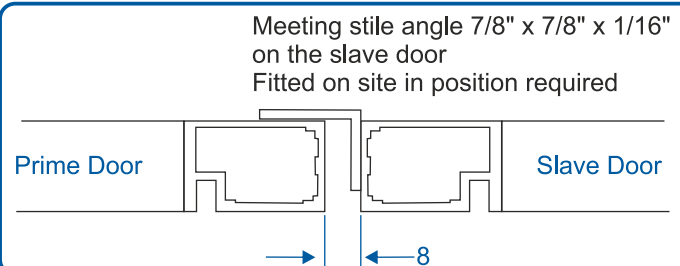
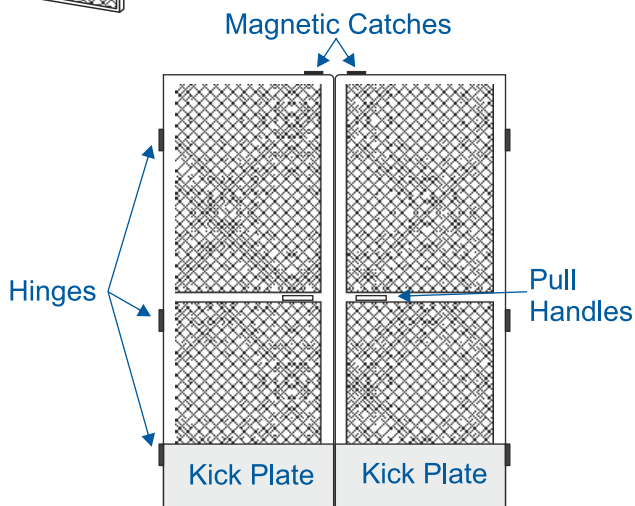

Note: Maximum handle clearance is 40mm from the inside face of the frame

Trickle Vents & Trims

Trickle Vents

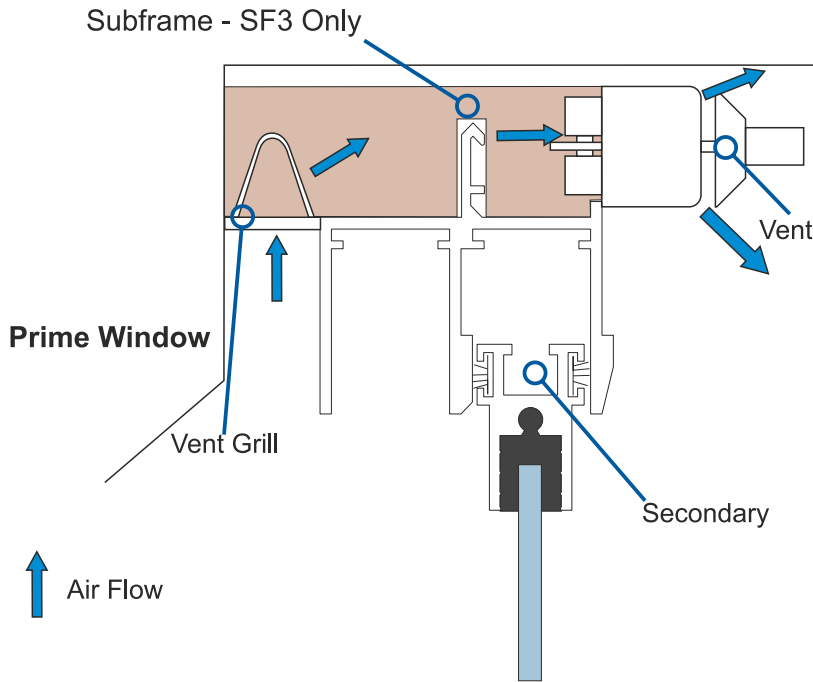

Trickle vents can only be used with a SF3 reveal fix subframe.

The vent is placed within the subframe and provides additional ventilation.

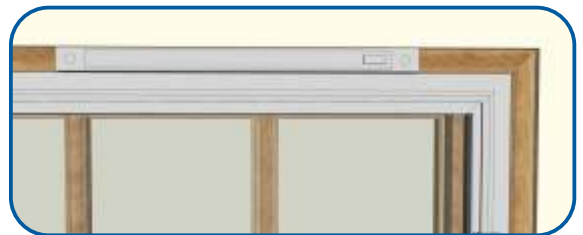

Trims

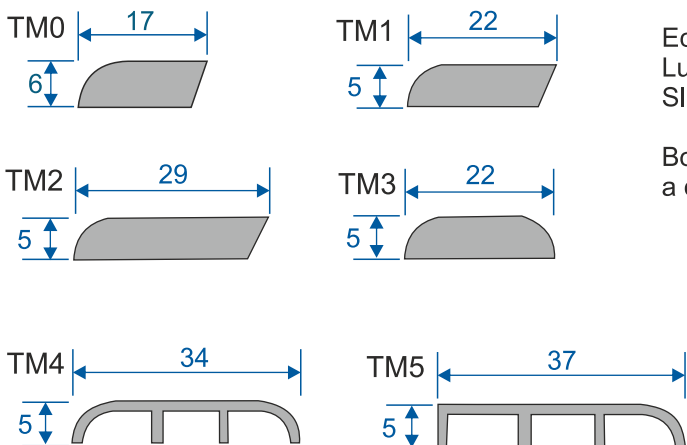

Economy odd leg, heavy duty & fixed are not provided with trims. Luxury Subframe is provided with TM1 white plastic as standard. Slim Line Equal leg is provided with TM0 primed tulip as standard.

Both luxury subframe and slim line equal leg can be provide with a different trim if requested at the point of order.

Trim material options:

- TM0 - Tulip, Primed Tulip or Solid Oak.
- TM1 - White Plastic, Tulip, Primed Tulip or Solid Oak.
- TM2 - White Plastic, Tulip, Primed Tulip or Solid Oak.
- TM3 - White Plastic, Tulip, Primed Tulip or Solid Oak.
- TM4 - White Plastic, Tulip, Primed Tulip or Solid Oak.
- TM5 - White Plastic, Tulip, Primed Tulip or Solid Oak.

We reserves the right to make changes to product specification. The images used are artistic representations and are not binding in detail, colour or specification.

Main Office & Factory

Units 4-5, t: 01268 681612 (20 lines)
Charfleets Road, f: 01268 510058
Canvey Island, e: sales@duration.co.uk
Essex. SS8 0PQ w: www.duration.co.uk

Product Showroom

Unit 1 Casino Parade, t: 01268 695100
Eastern Esplanade,
Canvey Island, SatNav Directions
Essex. SS8 7FJ Use: SS8 7DN.